

Ansicht A-A

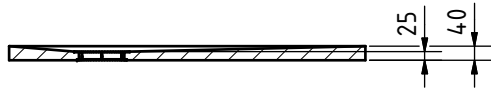

Ansicht B-B

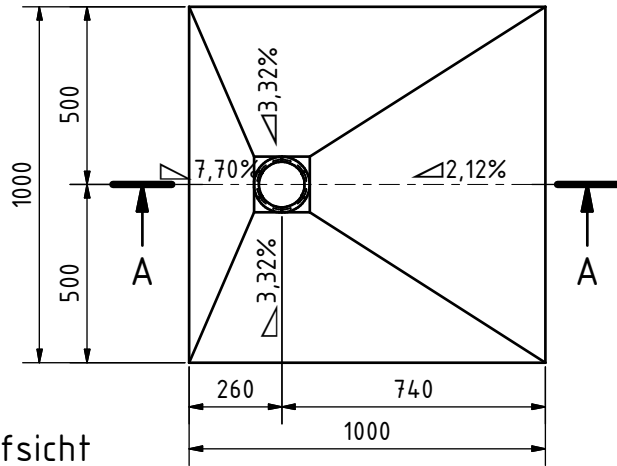

Draufsicht

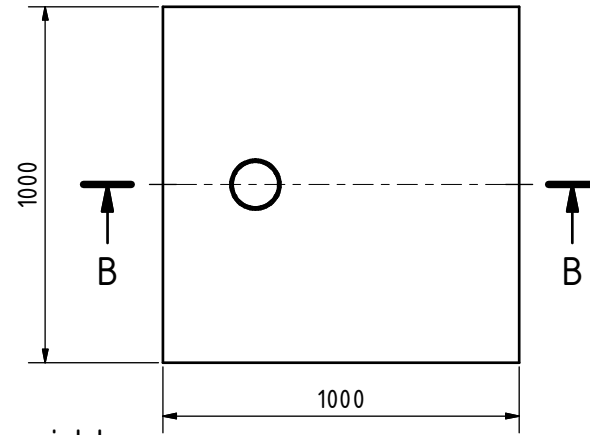

Unteransicht

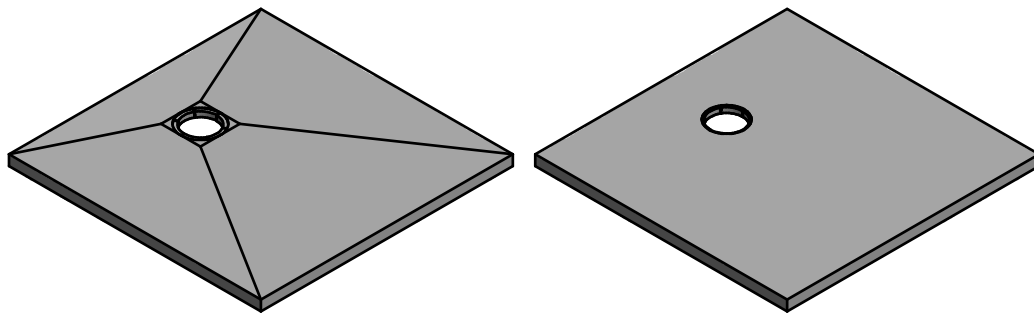

		Bautoleranz nach DIN 18202		Sale: 1:15	
		Duschboard Punktentwässerung dezentral Shower element with decentral point drainage			
		Datum		Name	
		Gezeichnet			
		Kontrolliert			
		Norm			
				Shower Tray DUB 0	
				1000x1000x40	
				1	
				A3	
Status	Änderungen	Datum	Name		